

Schleifscheiben-Aufnahme HSK
Grinding wheel adaptor HSK

Komplett mit Flanschscheiben
 Complete with flange wheel

Sonderausführungen nach Kundenwunsch lieferbar
 Special requirements available

Lieferumfang ohne Schleifscheiben
 Delivery without grinding wheel



**Bei Bestellung bitte
 Maschinentyp angeben!**

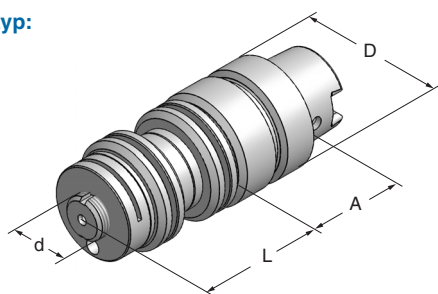

HSK - C 50

Maschinentyp:
SAACKE





Art.-Nr.	Typ	D	d	A	L
111650	HSK-C50x20x106	50	20	40	66
	inclusive				
112650	HSK-C50x20x140	50	20	40	100
	inclusive				

HSK - E 50

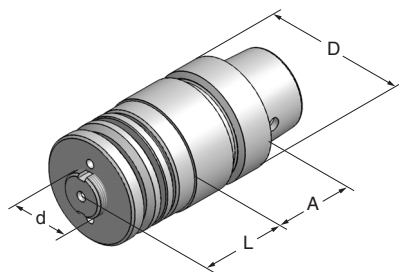
Maschinentyp:
HAAS





Art.-Nr.	Typ	D	d	A	L
114650	HSK-E50x20x 82	50	20	42	40
	inclusive				
115650	HSK-E50x20x102	50	20	42	60
	inclusive				

HSK - F 50

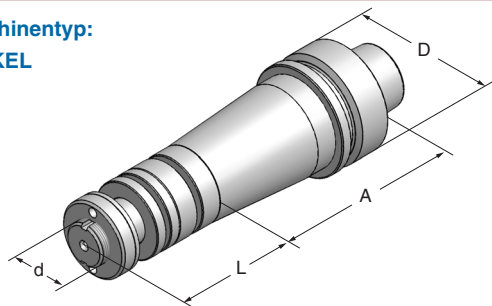
Maschinentyp:
DECKEL





Art.-Nr.	Typ	D	d	A	L
125650	HSK-F50x20x118	50	20	58	60
	inclusive				
126650	HSK-F50x20x168	50	20	88	60
	inclusive				

HSK - C 50

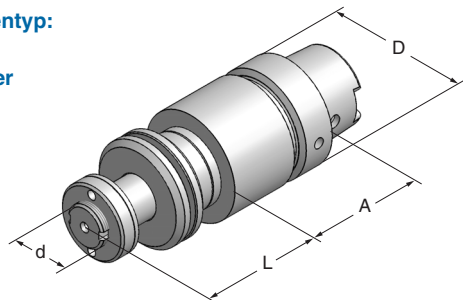
Maschinentyp:
**WALTER
 Heli-Power**



Art.-Nr.	Typ	D	d	A	L
131650	HSK-C50x20x115	50	20	55	60
	inclusive				
132650	HSK-C50x20x155	50	20	85	100
	inclusive				

Schleifscheiben-Aufnahme HSK
Grinding wheel adaptor HSK

Komplett mit Flanschscheiben
 Complete with flange wheel

Sonderausführungen nach Kundenwunsch lieferbar
 Special requirements available

Lieferumfang ohne Schleifscheiben
 Delivery without grinding wheel

*Bei Bestellung bitte
 Maschinentyp angeben!*





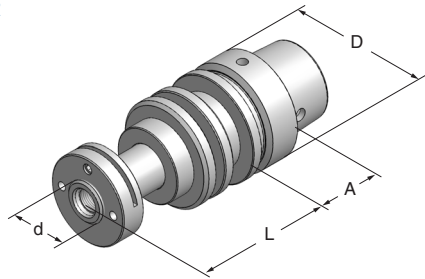

HSK - E 50

Maschinentyp:
REINECKER

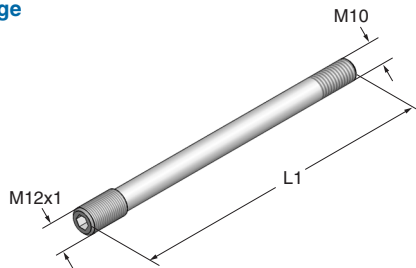

Anzugstange



Art.-Nr.	Typ	D	d	A	L
129650	HSK-E50xø20x 75	50	20	26	49
	inclusive				
119650	HSK-E50xø20x100	50	20	26	74
	inclusive				
137650	HSK-E50xø20x120	50	20	26	94
	inclusive				

Anzugstange

Art.-Nr.	für Typ	L1
642101	129650	125
643101	119650	150
644101	137650	170

HSK - C 50

Maschinentyp:
SCHNEEBERGER
Norma CFG

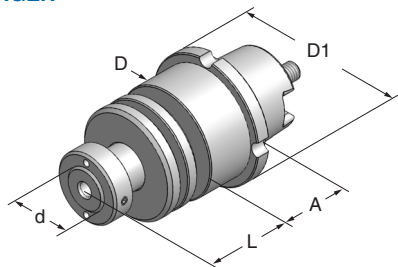

Art.-Nr.	Typ	D	D1	d	A	L
138650	HSK-C50xø20x75	50	58	20	30	45
	inclusive	